

1 2 3 4 5 6

inches

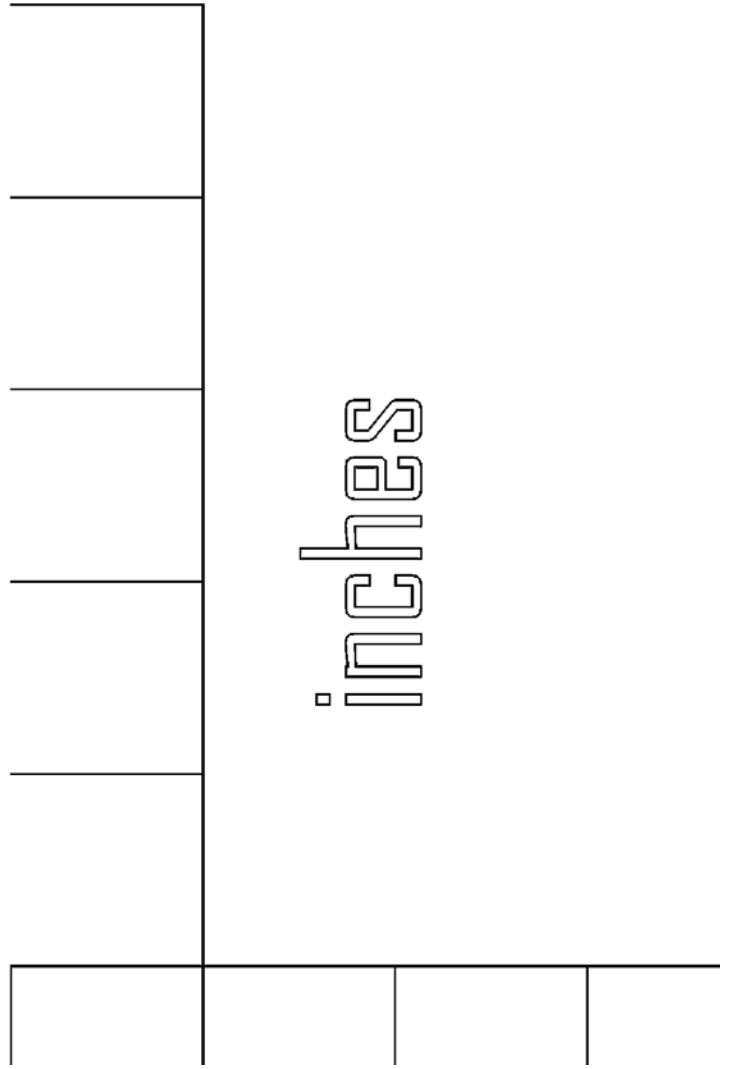

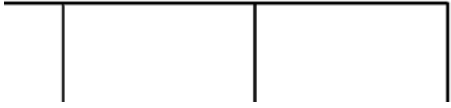

row

span

ngth

5 07

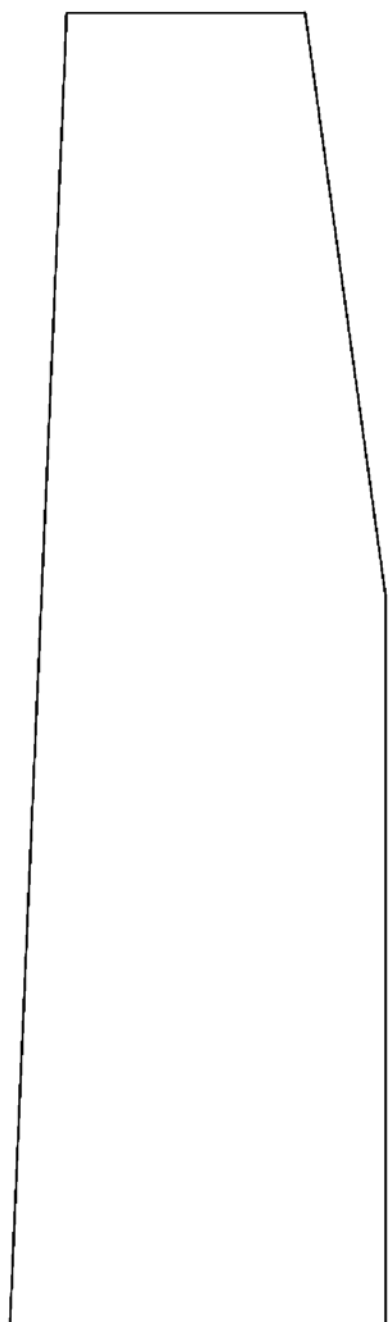
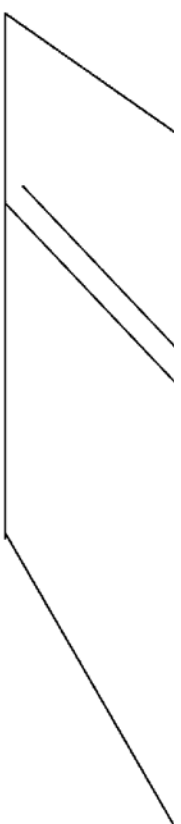

00 00  
jeab 00

07000

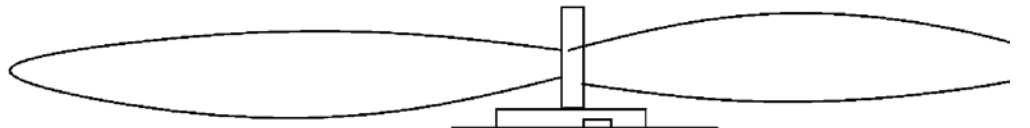

gws 300c

Carbon fiber tube

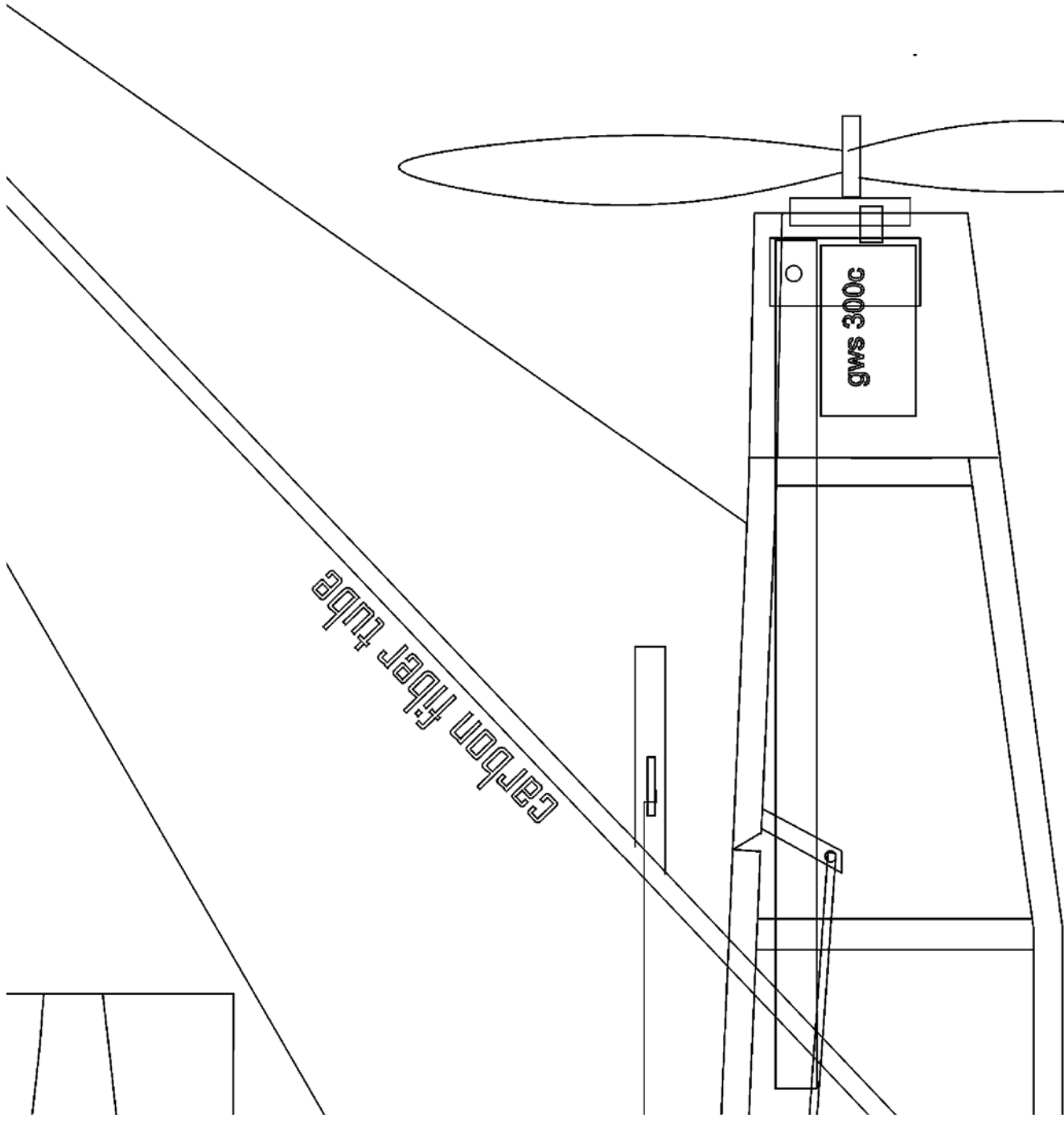

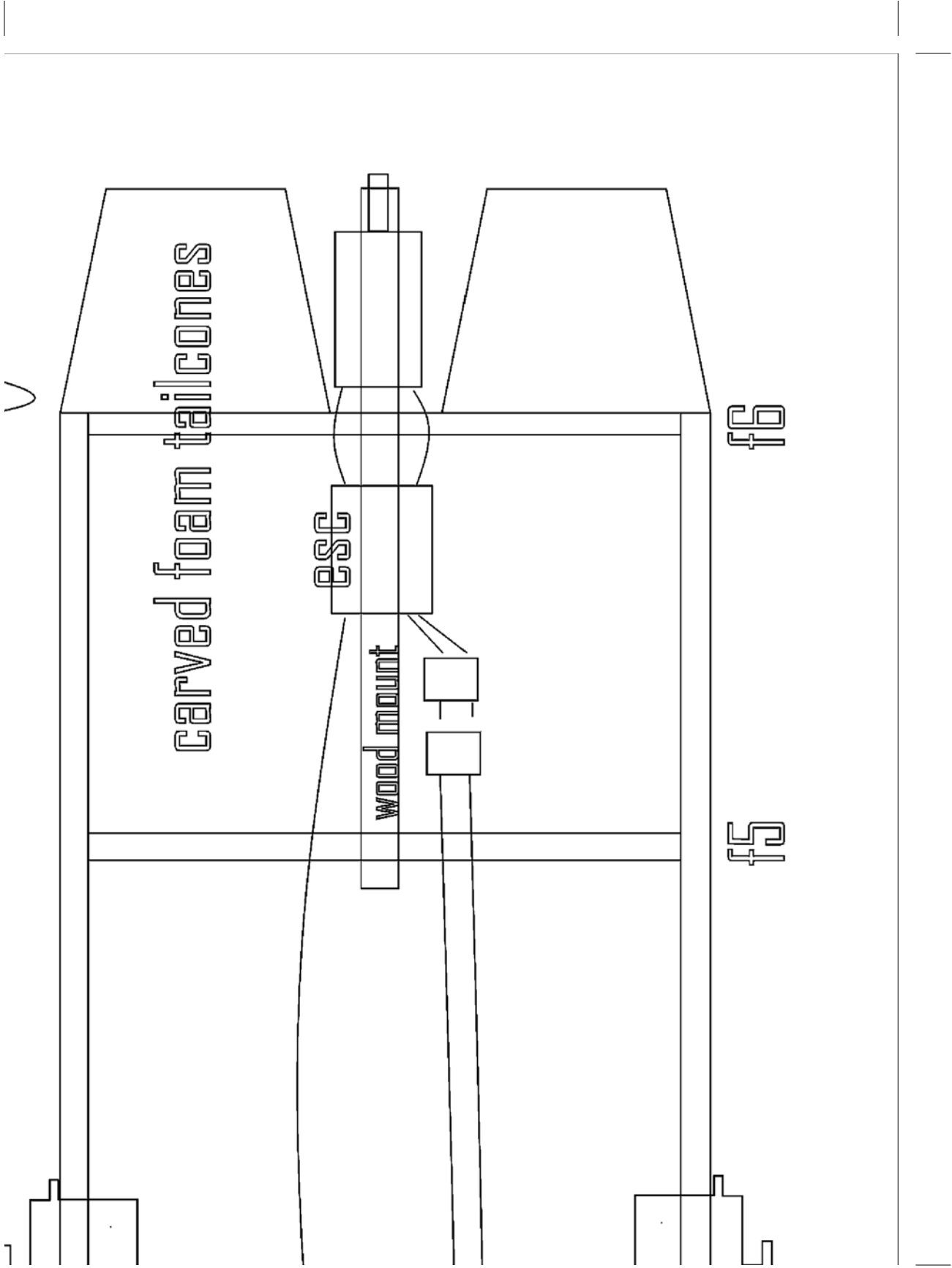

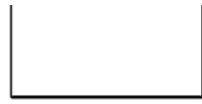

1

2

3

4

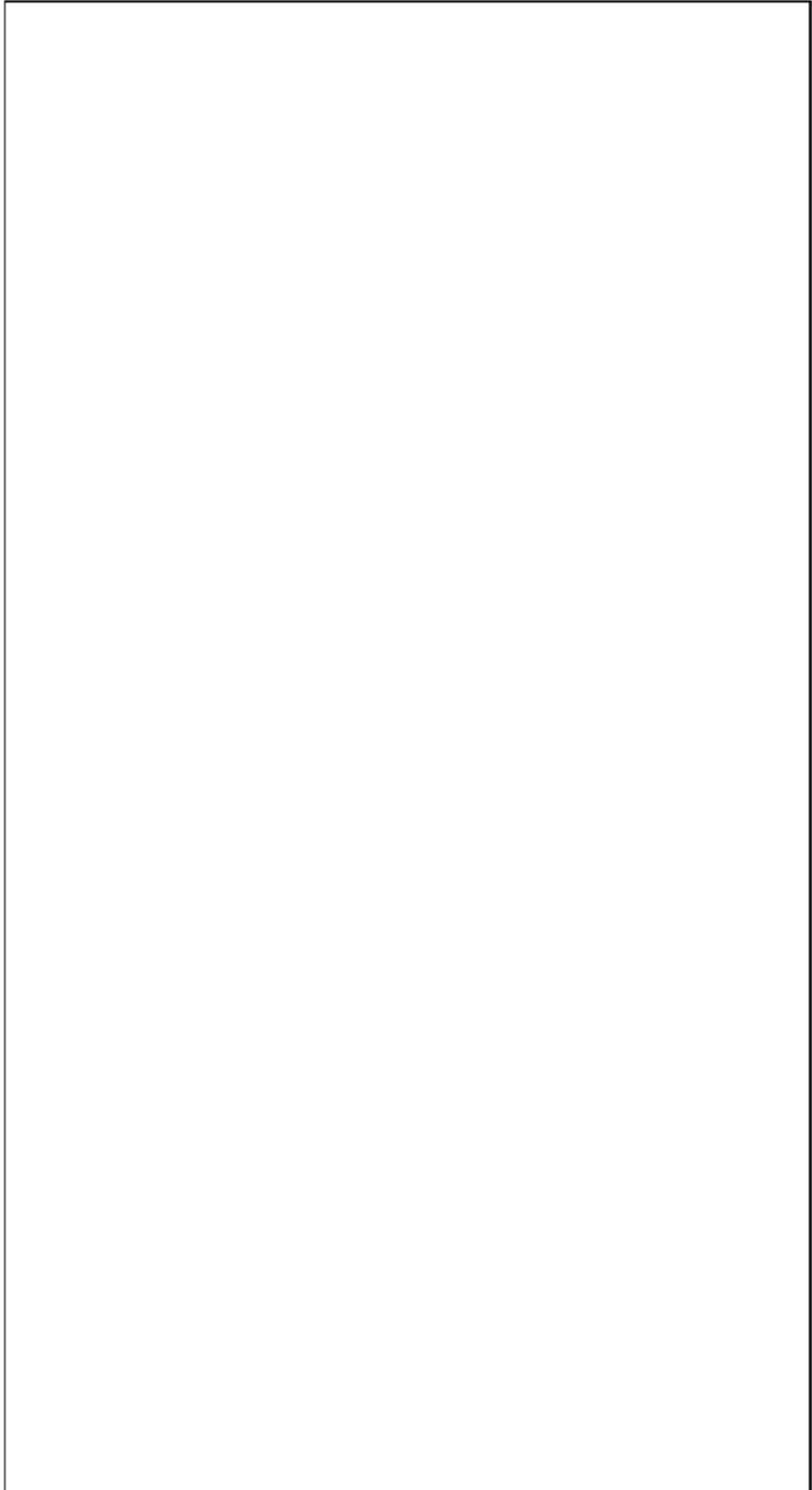

4—

5—

6—

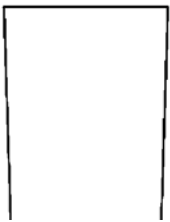

AVRO AI

24" wir

35" lei

A11W 11

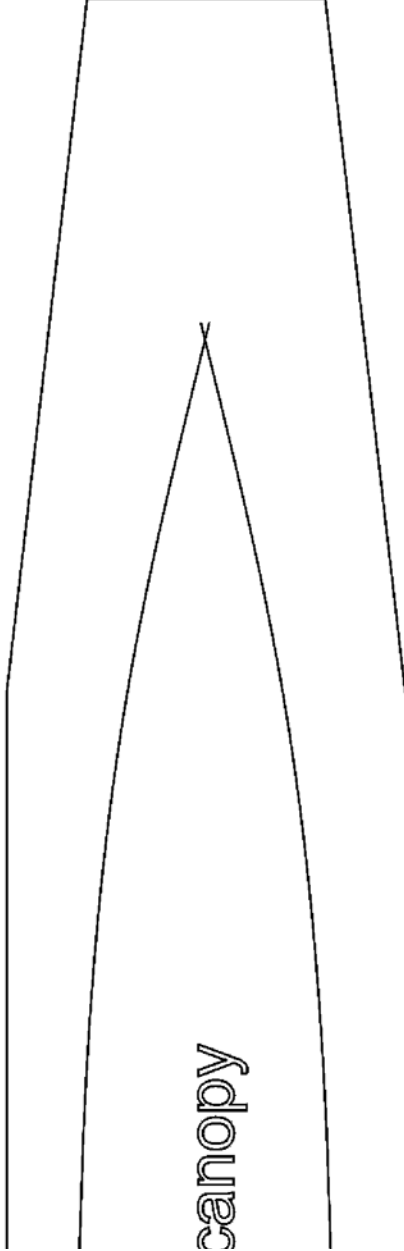

canopy

FAU WV II.  
GWS 31

---

side

---

---

side

---



carved foam canopy

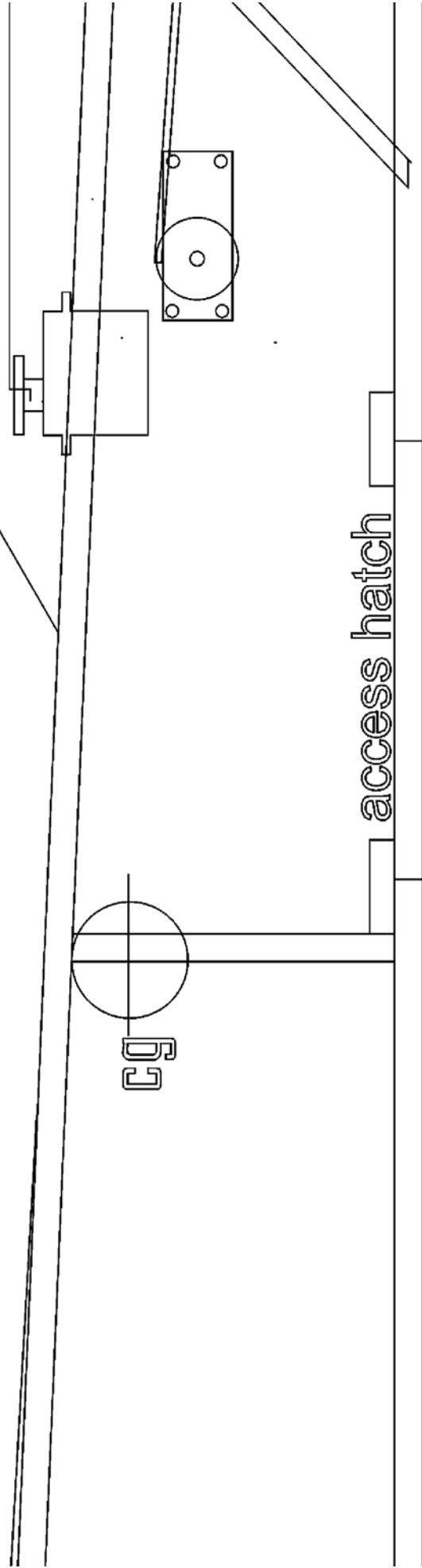
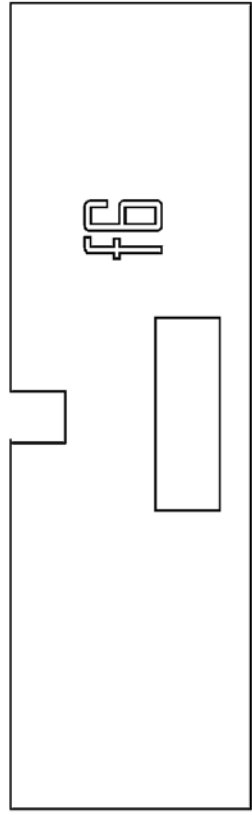
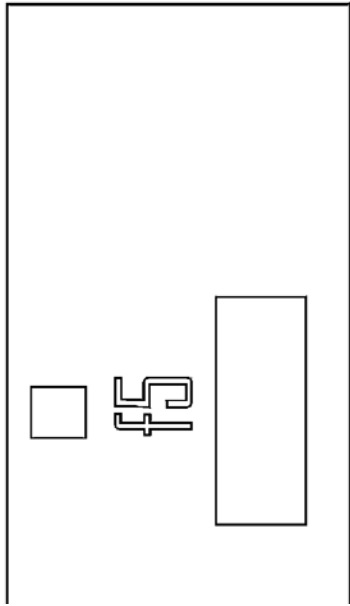

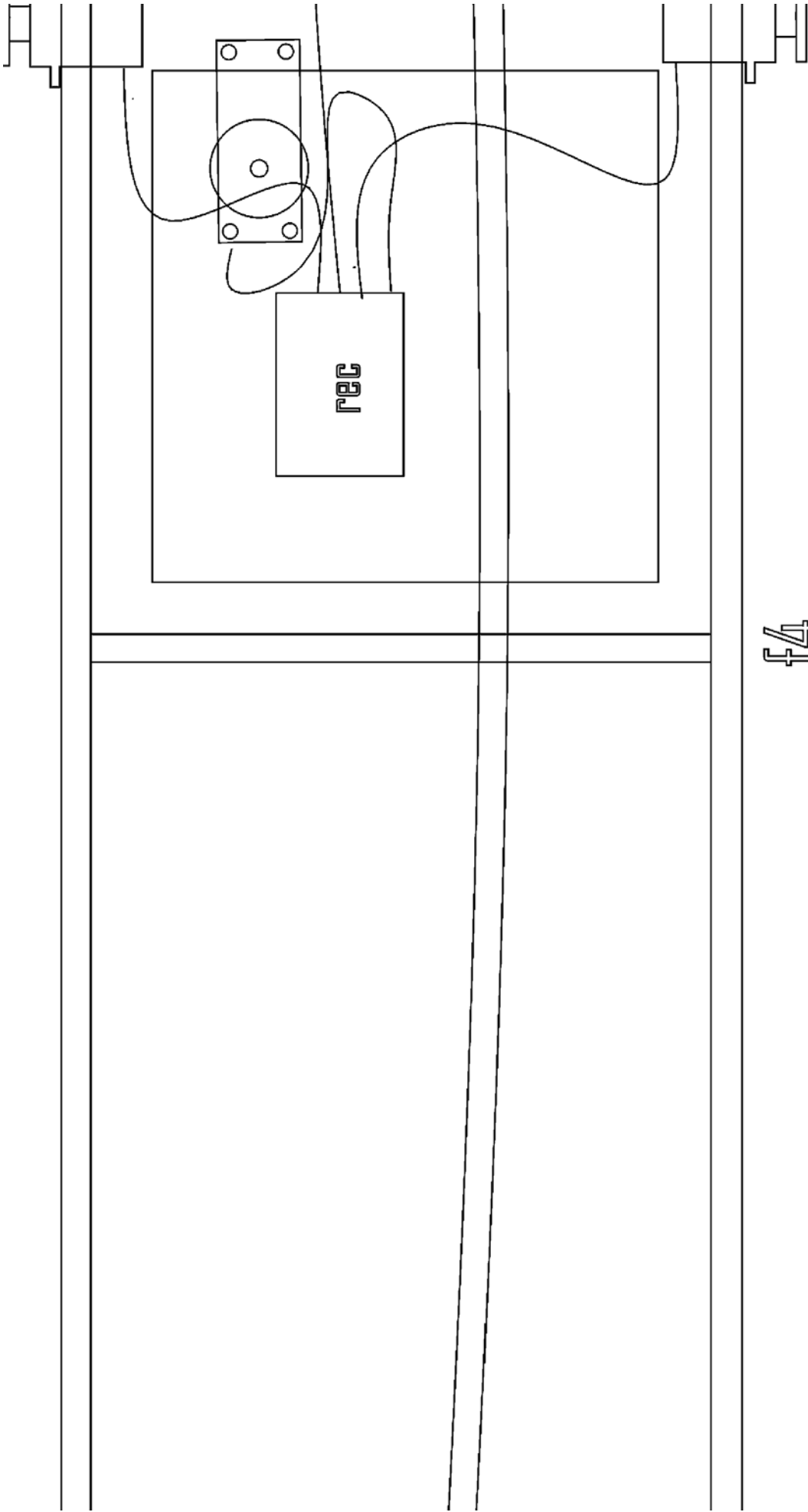

44

bottom

turbine cooling vent

carved foam (

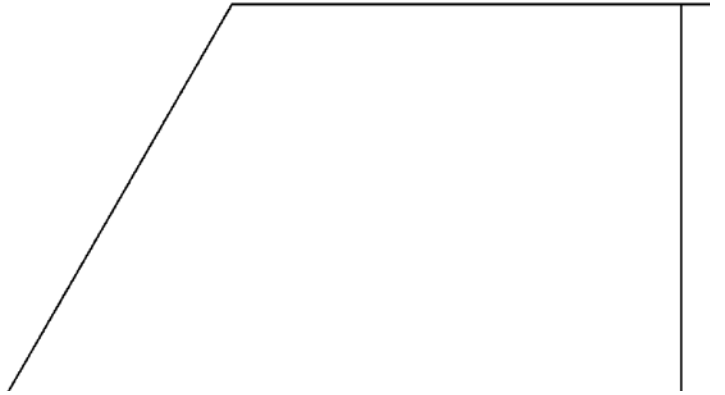
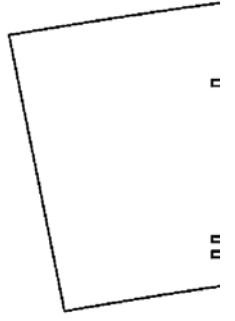

cardboard  
tailcone

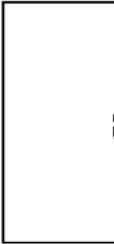
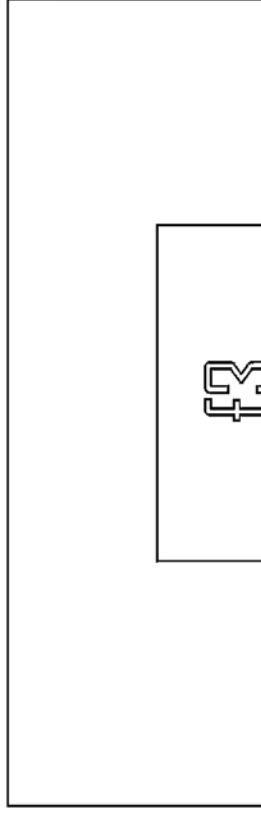
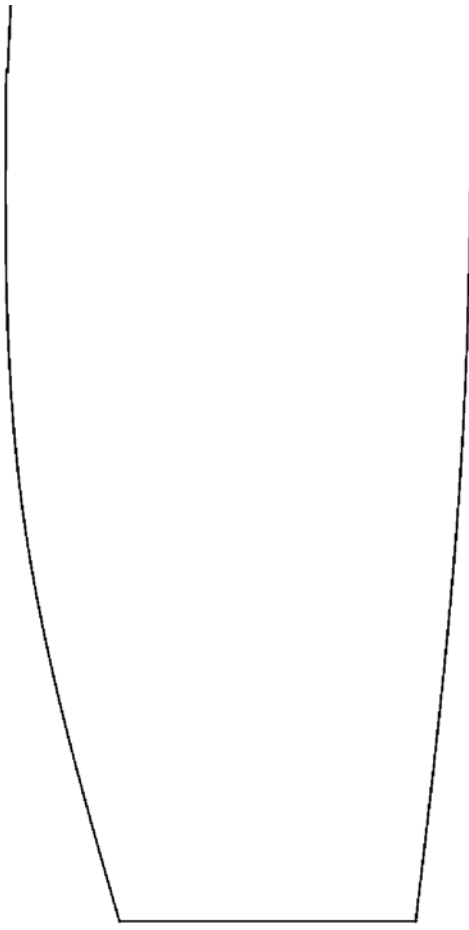
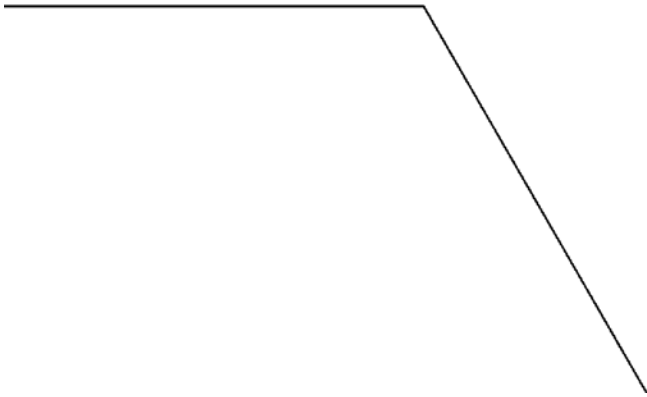
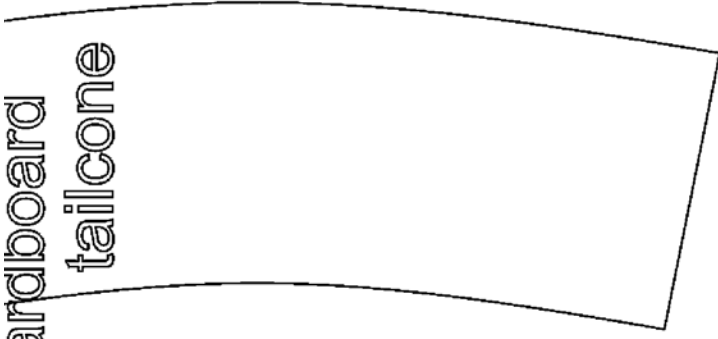

fy

i

top

13

14

f4

12

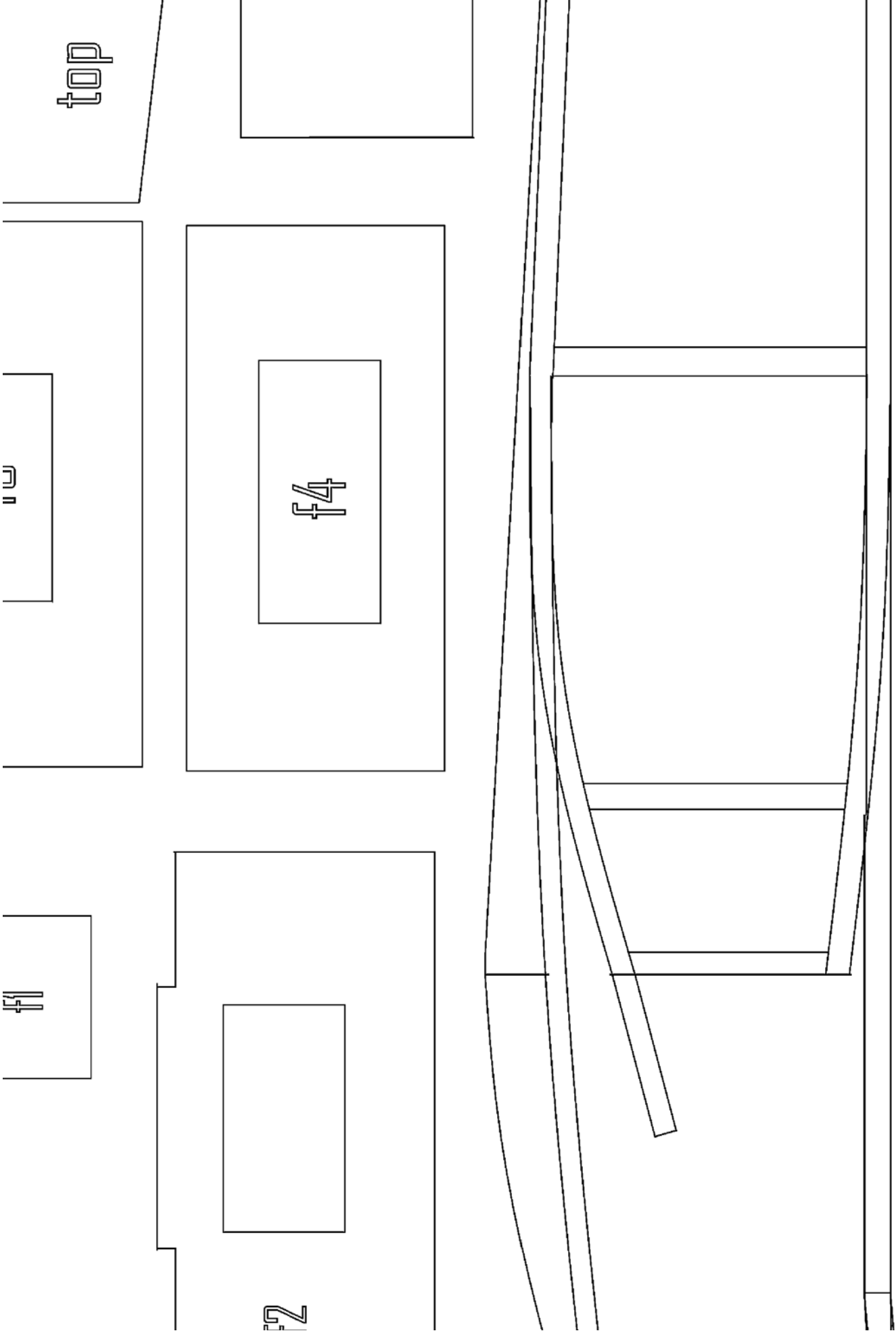

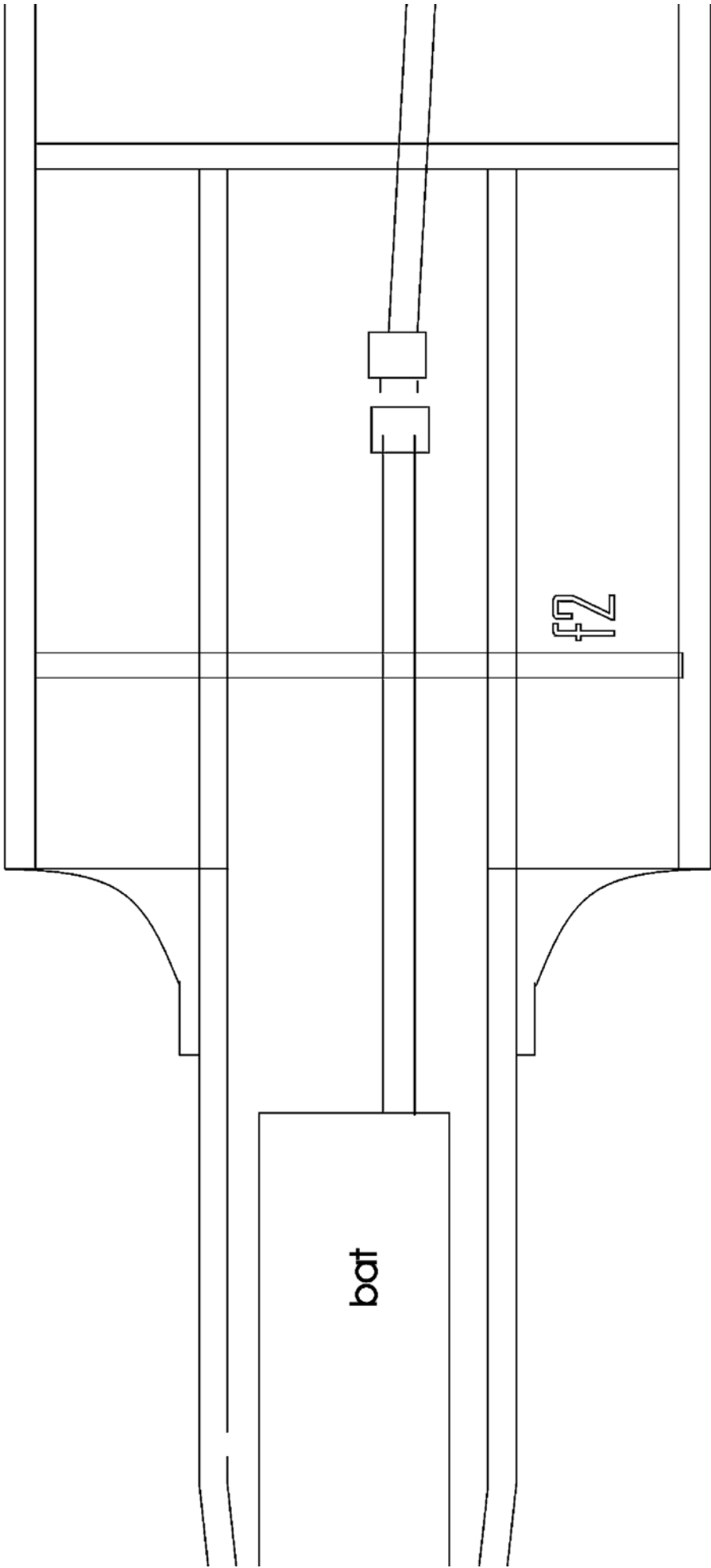

bat

f2

f3

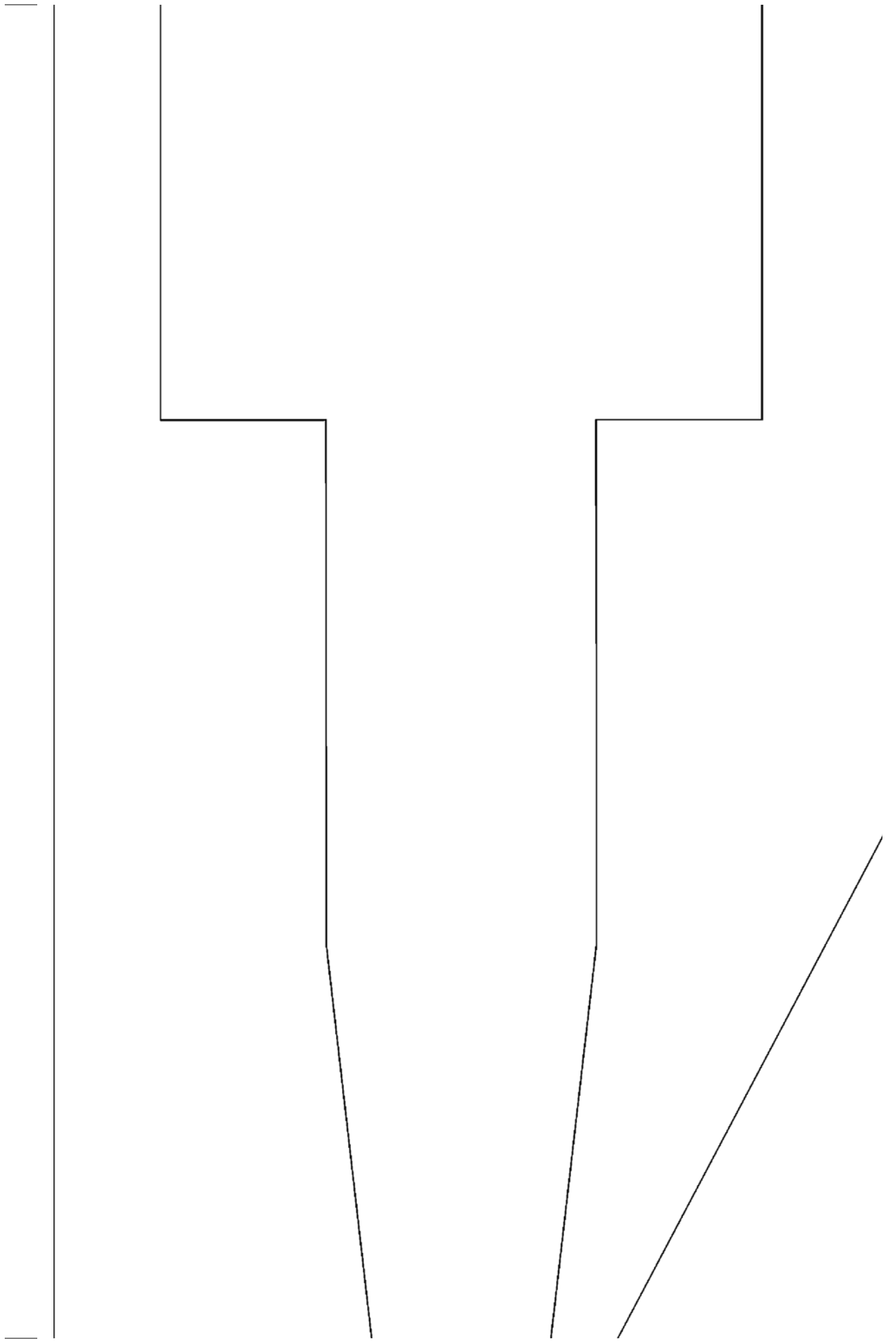



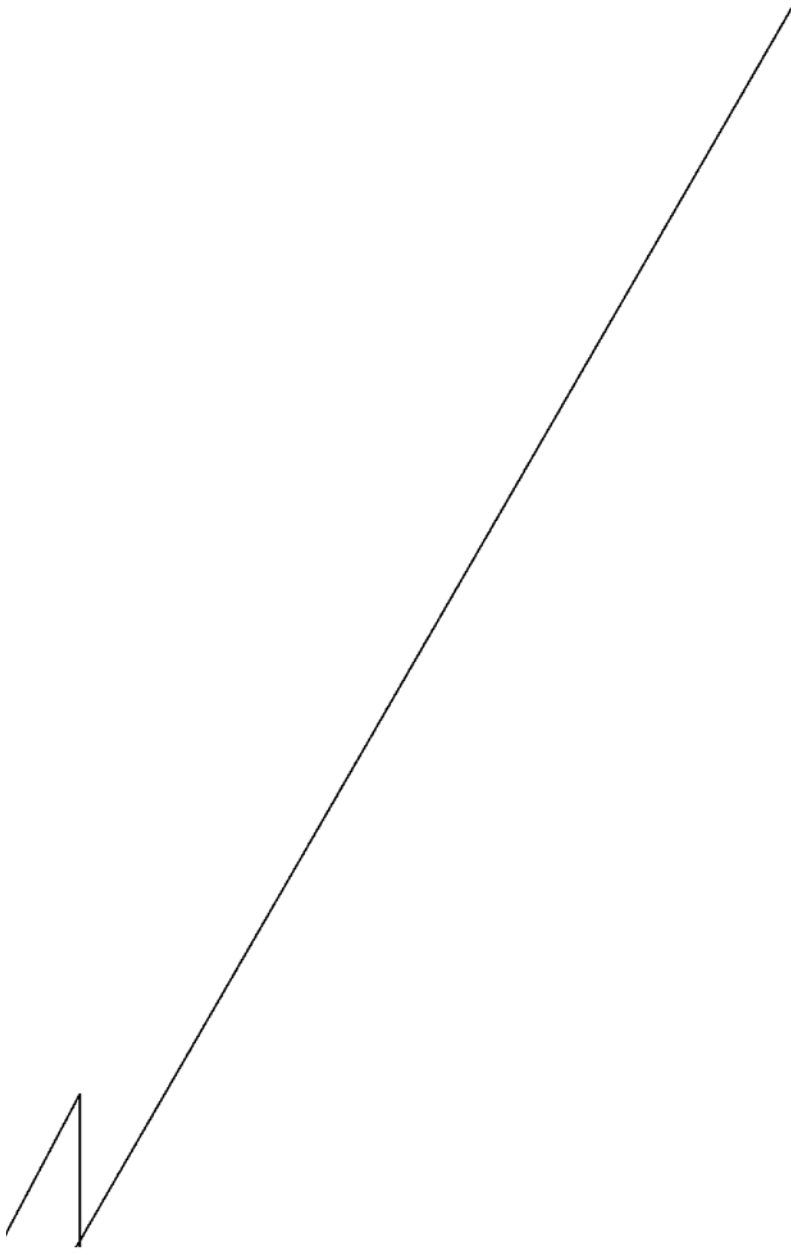

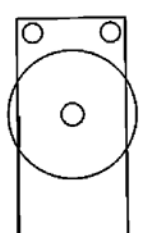
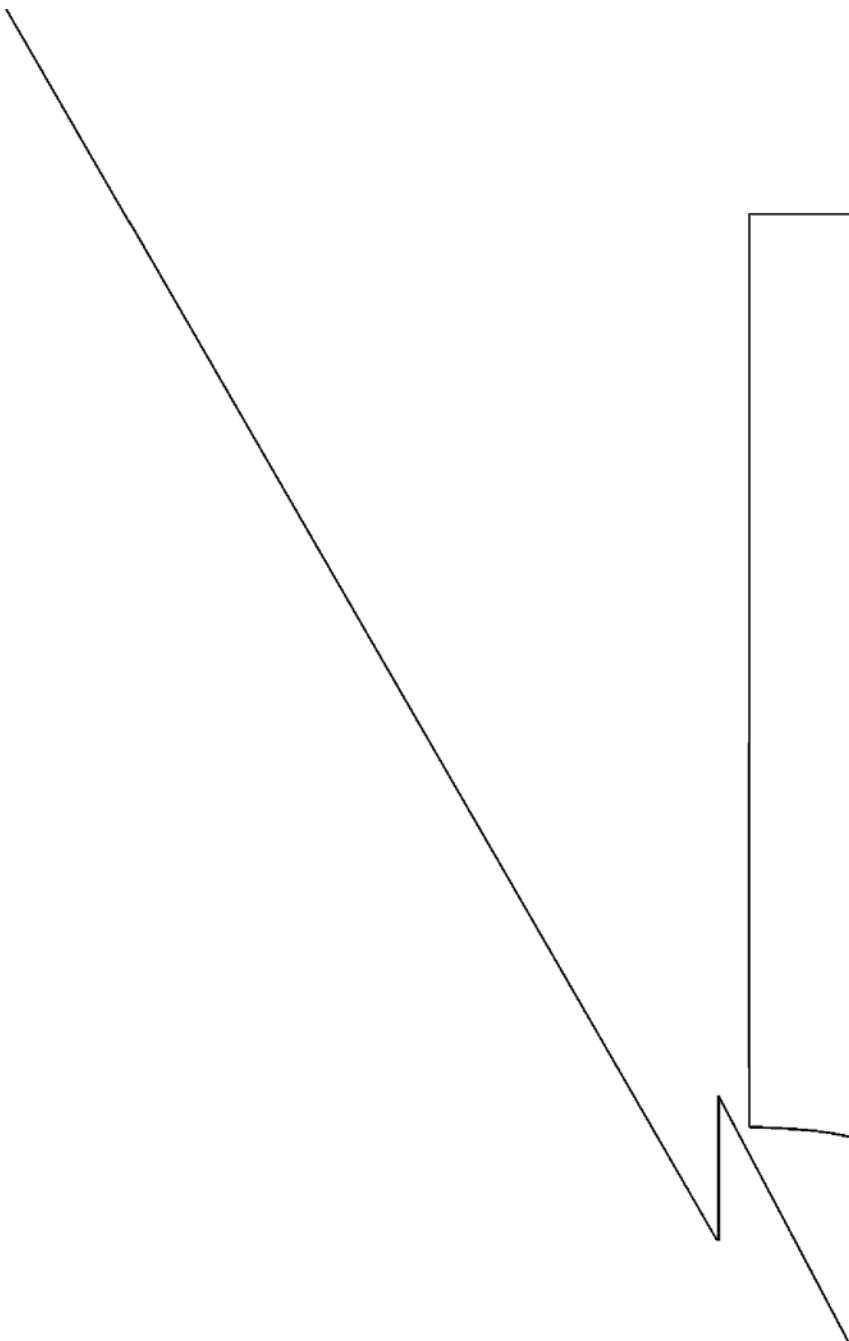

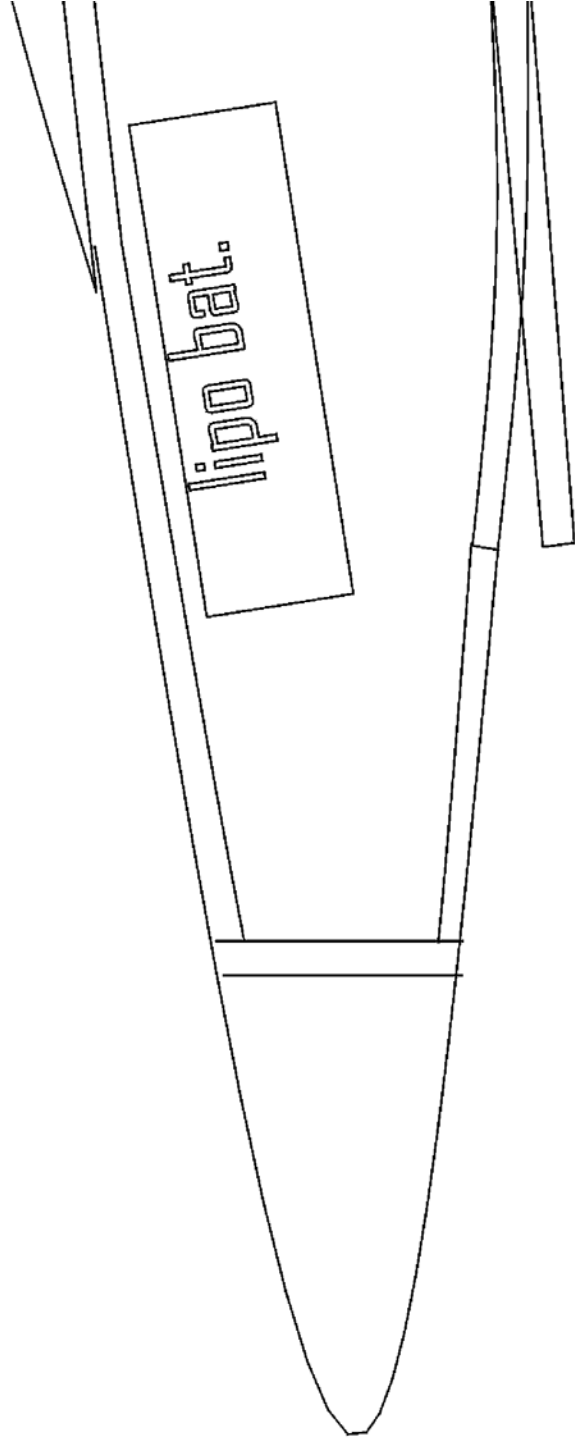
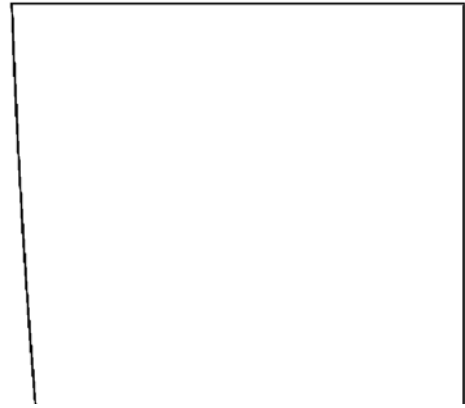
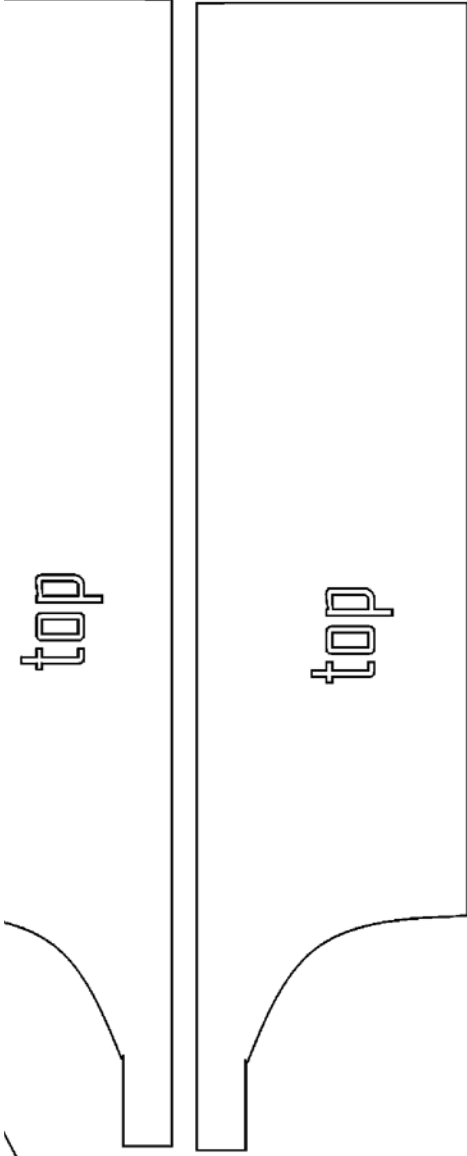
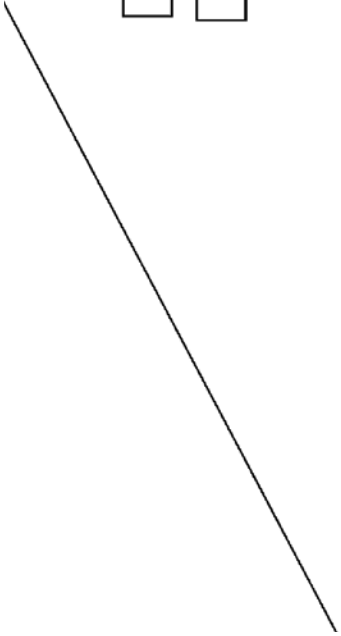

access hatch

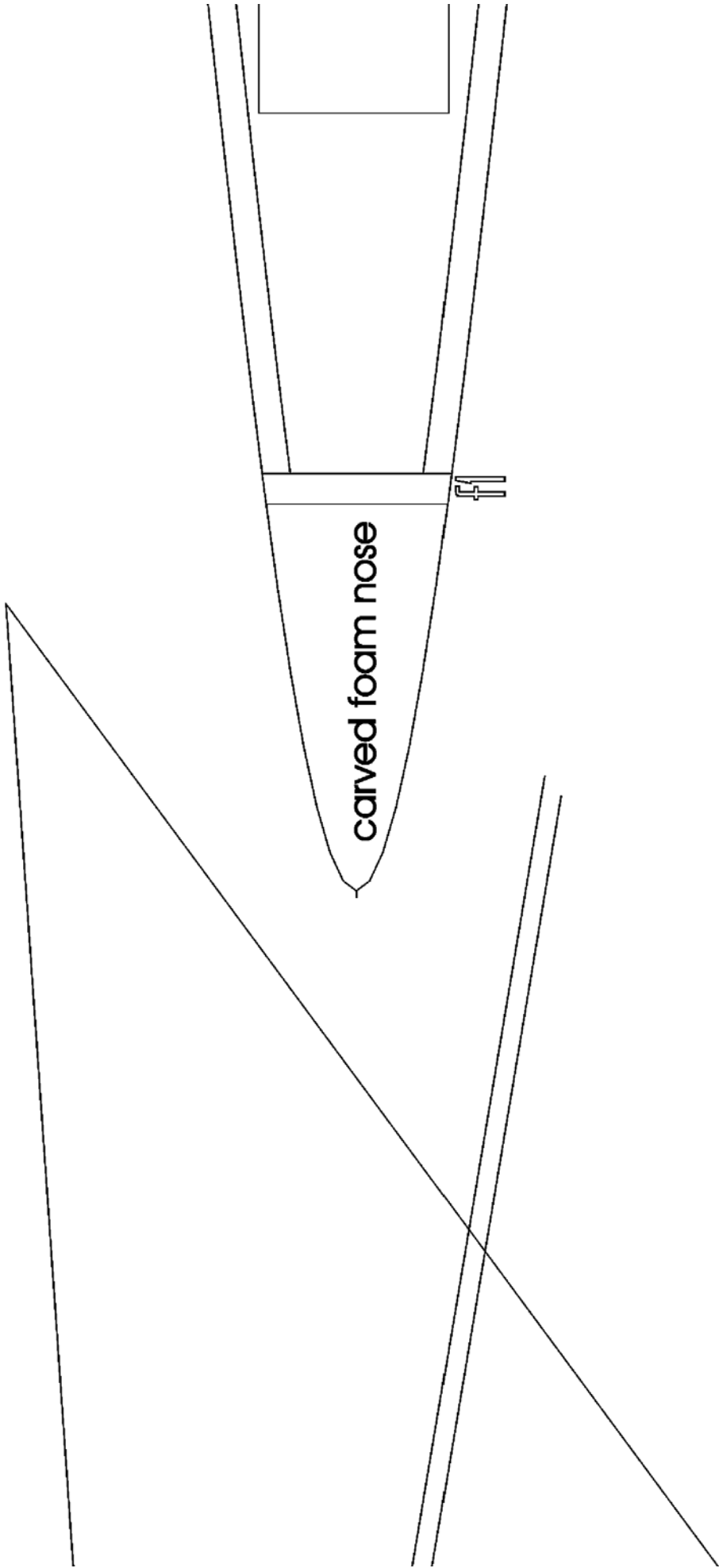

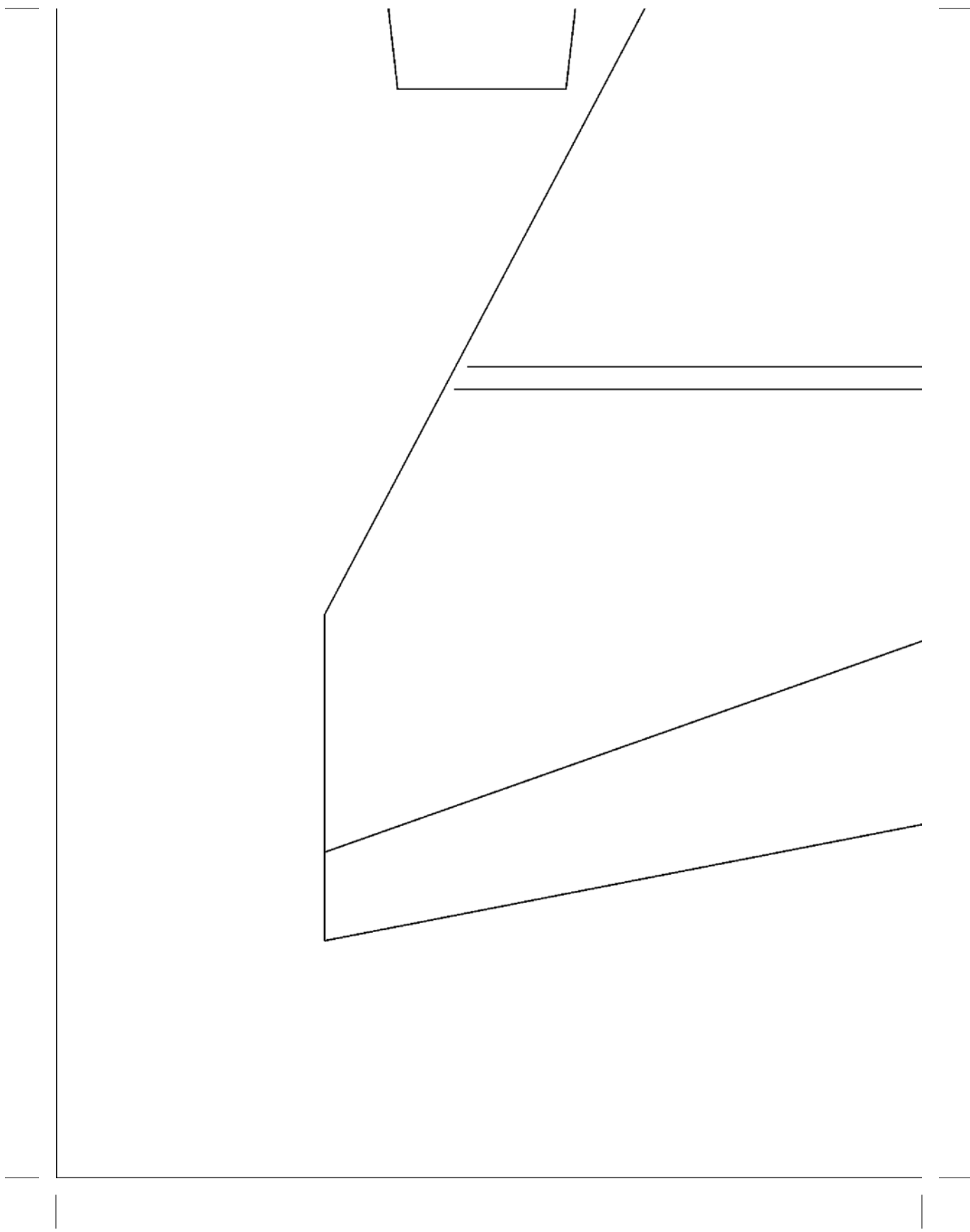

carbon fiber tube

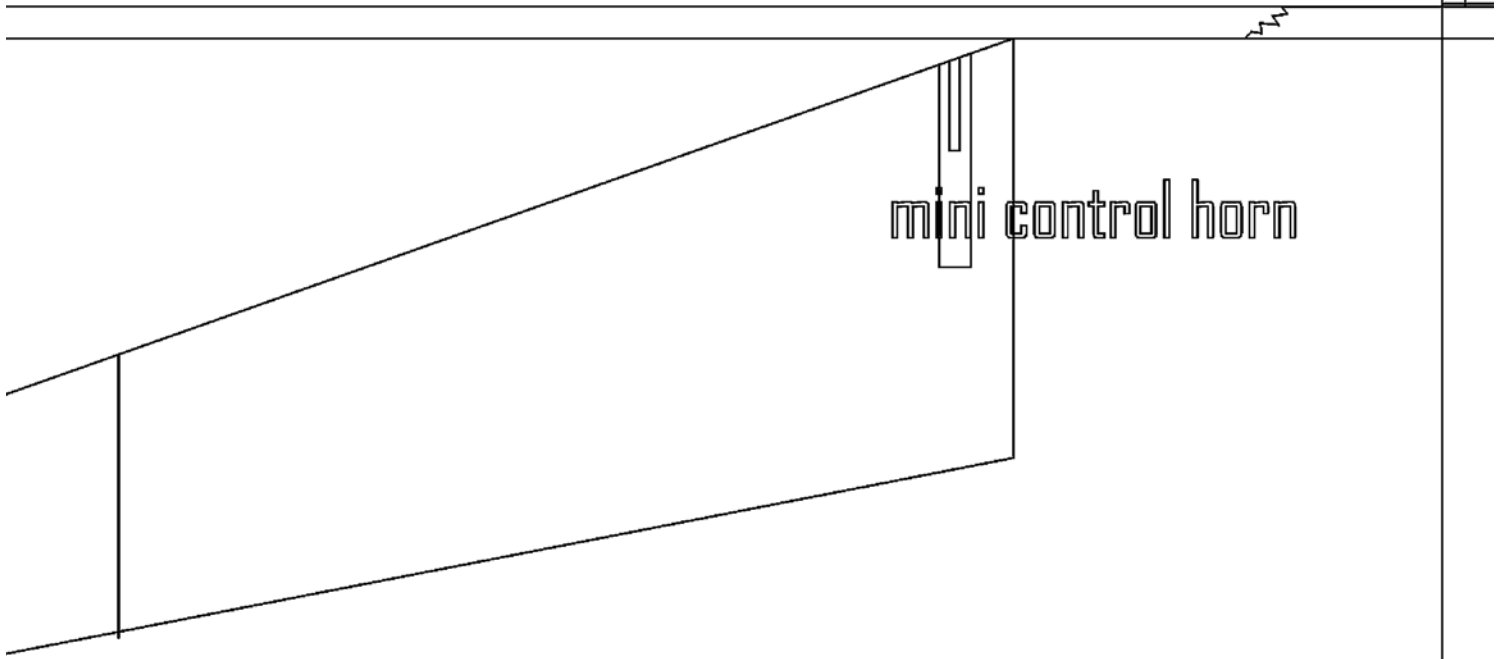

mini control horn

